

# N2S065004PE2

## Silicon Carbide Schottky Diode

$V_{RRM}$	=	650V
$I_F(T_C \leq 135^\circ\text{C})$	=	8A
$Q_c$	=	11.5nC

### Features

- New Thin Wafer Technology
- Low Forward Voltage Drop ( $V_F$ )
- Zero Reverse Recovery Current
- Zero Forward Recovery Voltage
- Positive Temperature Coefficient on  $V_F$
- Temperature-independent Switching

### Benefits

- Replace Bipolar with Unipolar Device
- Reduction of Heat Sink Size
- Parallel Devices Without Thermal Runaway
- Essentially No Switching Losses

### Applications

- Switch Mode Power Supplies
- Uninterruptible Power Supplies
- Motor drive, PV Inverter, Wind Power Station

### Package

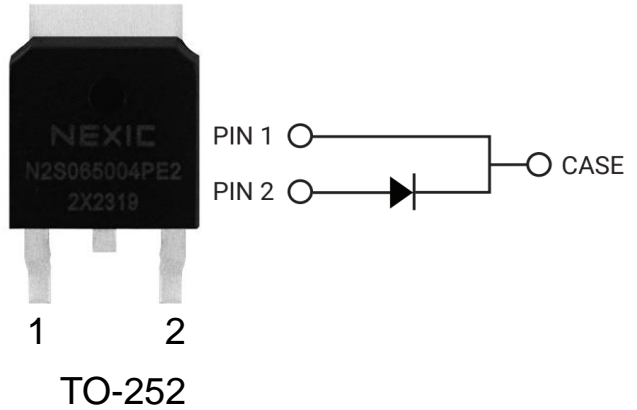

Part Number	Package	Marking
N2S065004PE2	TO-252	N2S065004PE2

### Maximum Ratings

Symbol	Parameter	Value	Unit	Test Conditions	Note
$V_{RRM}$	Repetitive Peak Reverse Voltage	650	V	$T_C = 25^\circ\text{C}$	
$V_{RSM}$	Surge Peak Reverse Voltage	650	V	$T_C = 25^\circ\text{C}$	
$V_R$	DC Blocking Voltage	650	V	$T_C = 25^\circ\text{C}$	
$I_F$	Forward Current	8 4	A	$T_C \leq 135^\circ\text{C}$ $T_C \leq 160^\circ\text{C}$	
$I_{FSM}$	Non-Repetitive Forward Surge Current	32	A	$T_C = 25^\circ\text{C}$ , $t_p = 8.3\text{ms}$ , Half Sine Wave	
$P_{tot}$	Power Dissipation	60	W	$T_C = 25^\circ\text{C}$	Fig.3
$T_J, T_{STG}$	Operating Junction and Storage Temperature	-55 to 175	$^\circ\text{C}$		

## Electrical Characteristics

Symbol	Parameter	Typ.	Max.	Unit	Test Conditions	Note
$V_F$	Forward Voltage	1.28 1.40	1.5 1.6	V	$I_F = 4A, T_J = 25^\circ C$ $I_F = 4A, T_J = 175^\circ C$	Fig.1
$I_R$	Reverse Current	4 20	50 200	$\mu A$	$V_R = 650V, T_J = 25^\circ C$ $V_R = 650V, T_J = 175^\circ C$	Fig.2
C	Total Capacitance	250 26 19	/	pF	$V_R = 0.1V, T_J = 25^\circ C, f = 1MHz$ $V_R = 200V, T_J = 25^\circ C, f = 1MHz$ $V_R = 400V, T_J = 25^\circ C, f = 1MHz$	Fig.5
$Q_C$	Total Capacitive Charge	11.5	/	nC	$V_R = 400V, I_F = 4A$ $di/dt = 200A/\mu s, T_J = 25^\circ C$	Fig.4

## Thermal Characteristics

Symbol	Parameter	Typ.	Unit	Note
$R_{\theta JC}$	Thermal Resistance from Junction to Case	2.5	$^\circ C/W$	Fig.6
$R_{\theta JA}$	Thermal Resistance from Junction to Ambient	120	$^\circ C/W$	
$T_{sold}$	Soldering Temperature	260	$^\circ C$	

## Typical Performance

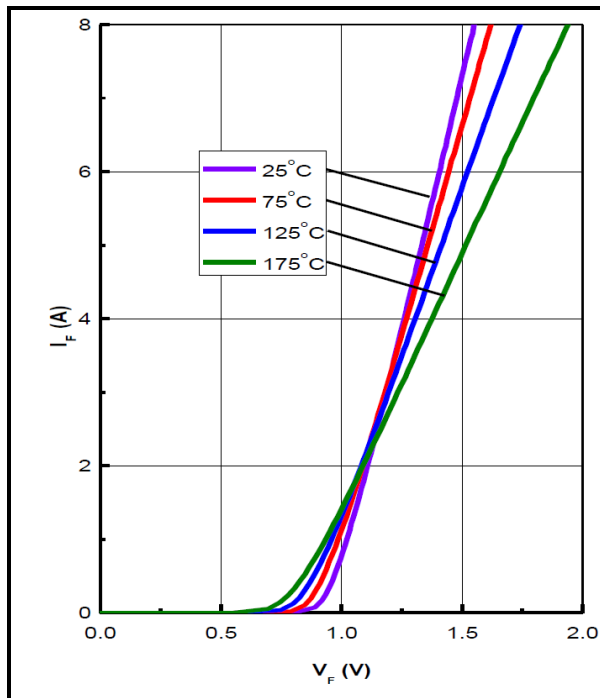

Figure 1. Forward Characteristics

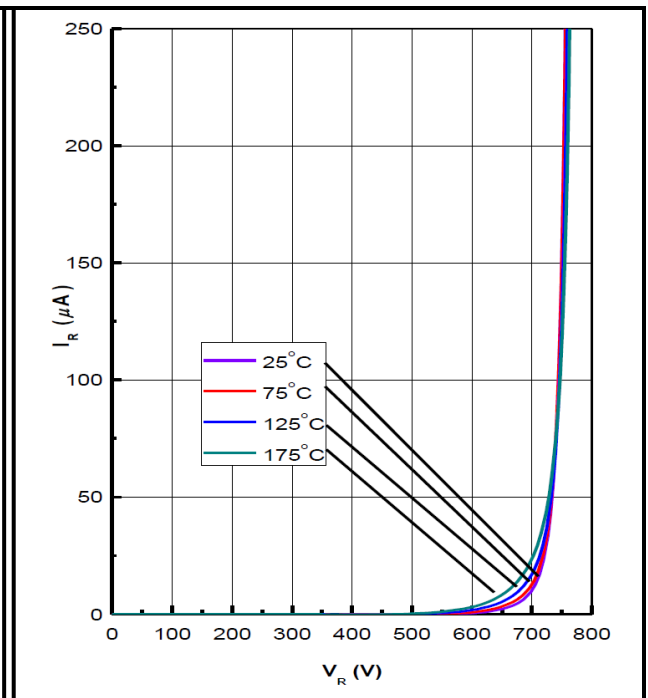

Figure 2. Reverse Characteristics

## Typical Performance

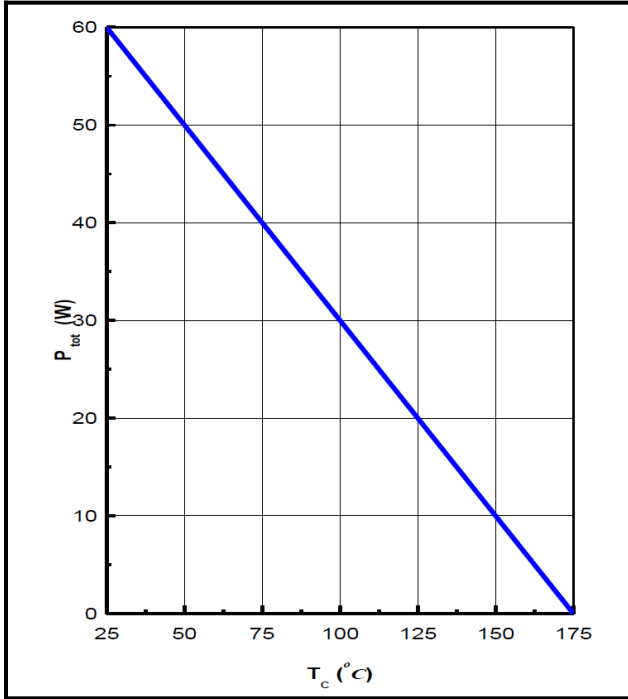

Figure 3. Power Derating

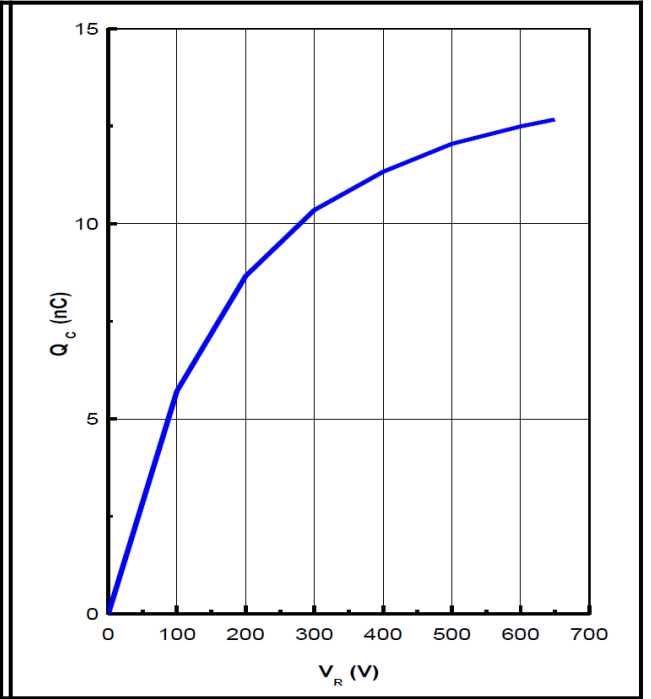

Figure 4. Total Capacitive Charge vs. Reverse Voltage

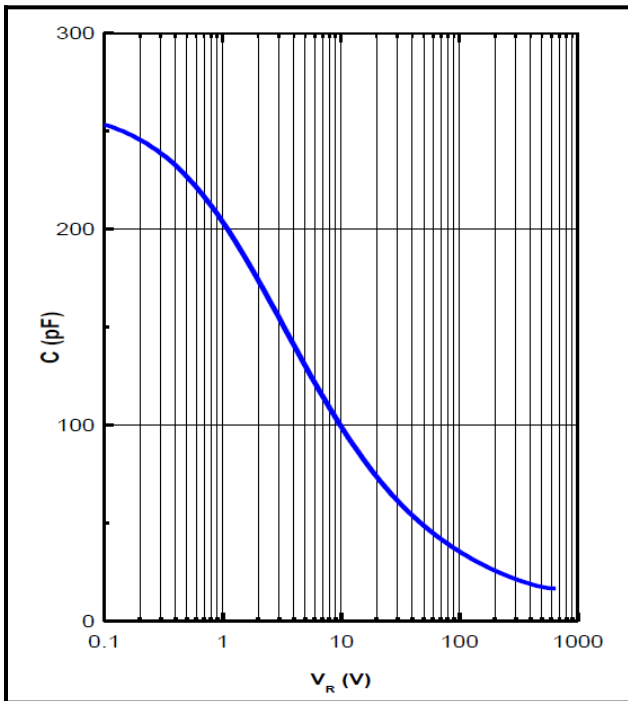

Figure 5. Total Capacitance vs. Reverse Voltage

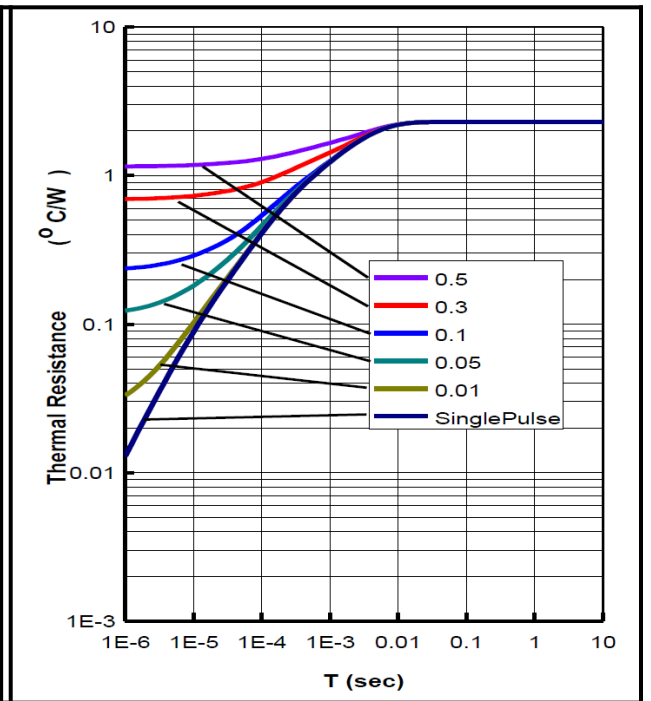
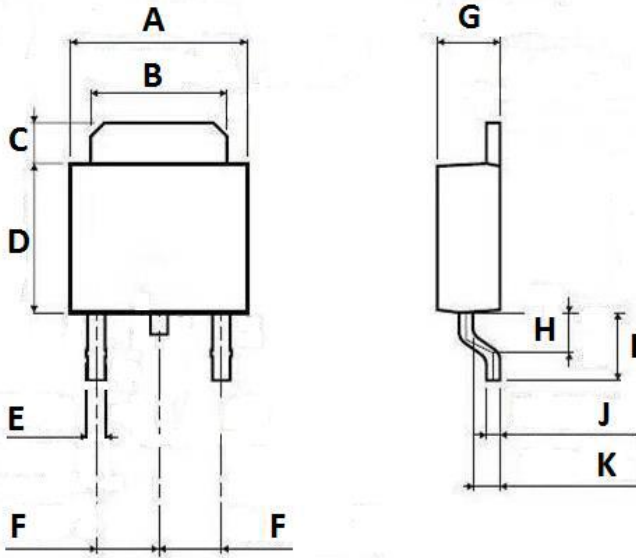
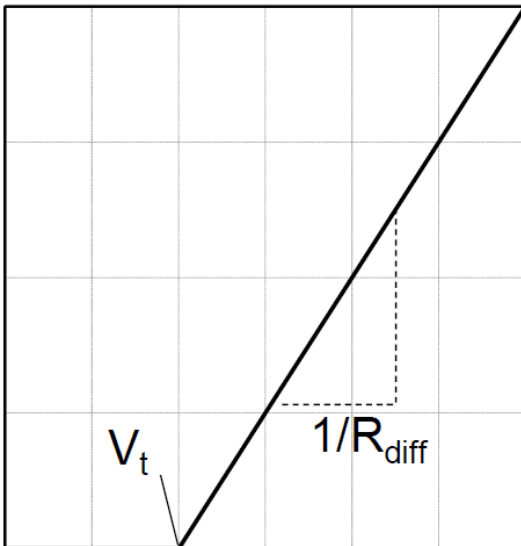

Figure 6. Transient Thermal Impedance

**Package Dimensions**
**Package TO-252**

SYMBOL	mm		
	MIN	NOM	MAX
A	6.30	6.50	6.70
B	5.20	5.30	5.40
C	1.15	1.25	1.35
D	5.70	5.90	6.10
E	0.65	0.70	0.75
F	2.10	2.30	2.50
G	2.20	2.30	2.40
H	1.45	1.50	1.55
I	2.90	3.00	3.10
J	0.45	0.50	0.55
K	0.90	1.00	1.10

**Simplified Diode Model**
**Equivalent IV Curve for Model**

**Mathematical Equation**

$$V_F = V_t + I_F \times R_{diff}$$

$$V_t = -0.001 \times T_j + 0.994 \text{ [V]}$$

$$R_{diff} = 1.73 \times 10^{-6} \times T_j^2 + 1.09 \times 10^{-4} \times T_j + 0.07 \text{ [\Omega]}$$

**Note:**

$T_j$  = Diode Junction Temperature In Degrees Celsius, valid from 25°C to 175°C

$I_F$  = Forward Current Less than 8A